

We would you like to thank you for choosing an ezcap™ product. You have made an excellent decision. The following contents guide you how to use the product. Hope this device will bring you nice digital experience

Overview

You now have all the options you need for recording your favorite movies, TV shows, or life video from an analog video source onto your computer. And edit them, and burn DVD disc, and send them to your iPod, PSP, or 3GP Mobile Phone. So you can watch them any where and any time.

The **ezcap™ USB 2.0 Video Capture**, it can capture High-quality video and audio file directly by USB 2.0 interface without sound card. The installation is very simple and the external power is unnecessary.

The **ezcap™ USB 2.0 Video Capture** has a snapshot button that allows you to take still photos.

The **ezcap™ USB 2.0 Video Capture** includes a professional video editing software – “ArcSoft ShowBiz DVD 2”. It can provide best editing function for you. ShowBiz DVD 2 is a video-editing software that makes editing your videos as fun as shooting them. ShowBiz DVD 2 helps novice users finish stylish movies in only few steps. Share finished projects on DVD, tape, the Web, and mobile devices.

The **ezcap™ USB 2.0 Video Capture** includes a powerful video converting software – “Magic 3.0”. You can transfer videos to your iPod, PSP, or 3GP Mobile Phone.

Specification

Item Name	USB 2.0 Video Capture
Model Number	ezcap116
Interface	USB 2.0 standard
TV System	PAL, NTSC
Recording Format	AVI, MPEG1/2
Converting Format	AVI-MPEG4,AVI-DIVX,MP4-MPEG4(iPod),3GP-MPEG4,PSP-MPEG4,MOV-MPEG4
Input	Composite Video(RCA), S-Video(miniDIN 4pin), Audio L/R(RCA)
Resolution	NTSC 160 x 120 ~ 720 x 480, PAL 160 x 120 ~ 720 x 576
Rate	NTSC 30fps, PAL 25fps
Power Supply	USB Bus
Consumed Power	1.5W
Editing Software	ArcSoft ShowBiz DVD 2
Converting Software	Blaze Video Magic 3.0
Dimension / Weight	73(L)x30(W)x22(H)mm / 67g
Cable Length	80cm(USB), 7cm(Video/Audio)
System Requirements	One available USB 2.0 port
	Pentium4 CPU or above
	512MB RAM or above
	Graphics card supports DirectX 9.0C
	1GB free HDD space

ezcap

USB 2.0 Video Capture

	CD-ROM for installation
	DVD-R/RW for burning DVD
	Windows XP, Vista,Seven
	Video Capture device, Software CD(includes driver, application and manual)

Connection Guide

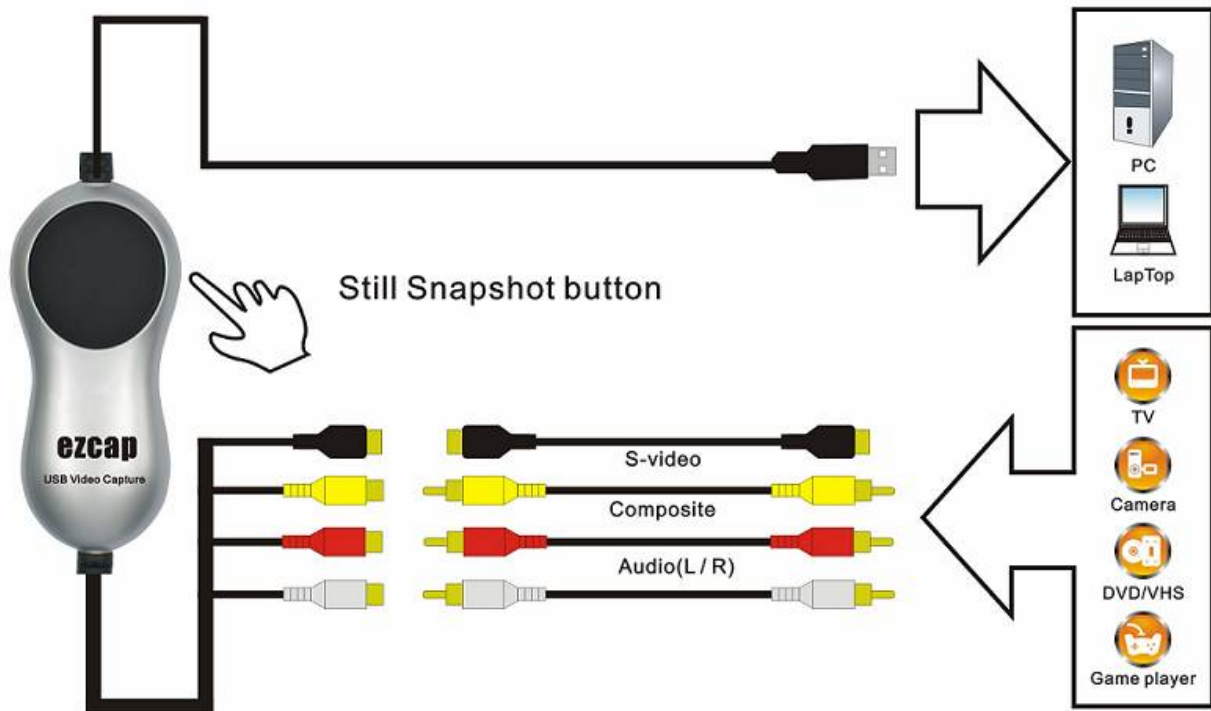

Notice:

1, You maybe have to buy Video and Audio cable, and S-Video cable to connect the USB Video Capture with your analog video device. You need to buy the Scart Video/Audio adapter if the output of your video source device is Scart type.

2, The following devices can be used as analog video sources:

Video recorder

DVD player

Video camera

Set-top box

Game player

Any device that provides an analog video signal

Quick Installation Chart

Please read the all installation guide clearly.

Please install the device hardware and software following below chart if you're very busy and want to use the device soon.



Step 1: Insert the CD-ROM to install the drivers and application software.

Step 2: Connect USB Video Capture with analog video source and computer.

Step 3: Open ShowBiz DVD 2 software to capture video and audio programs into your computer.

Step 4: Edit the recording video audio files with ShowBiz DVD 2 software.

Step 5: Convert the recording video audio files with Magic 3 software.

Step 6: Transfer the video audio files to your iPod, PSP, or 3GP Mobile Phone by iTunes.

Hardware Installation

Note: If you have any antivirus software enabled, please disable it during the installation of the software. Before you first connect the ezcap™ USB 2.0 Video Capture to your computer, please insert the “CD-ROM” into your CD drive. Then you should find a picture of software running.



Please select the option “Install Driver”. And system will appears you as below picture. Please click “Next” key to continue the installation.

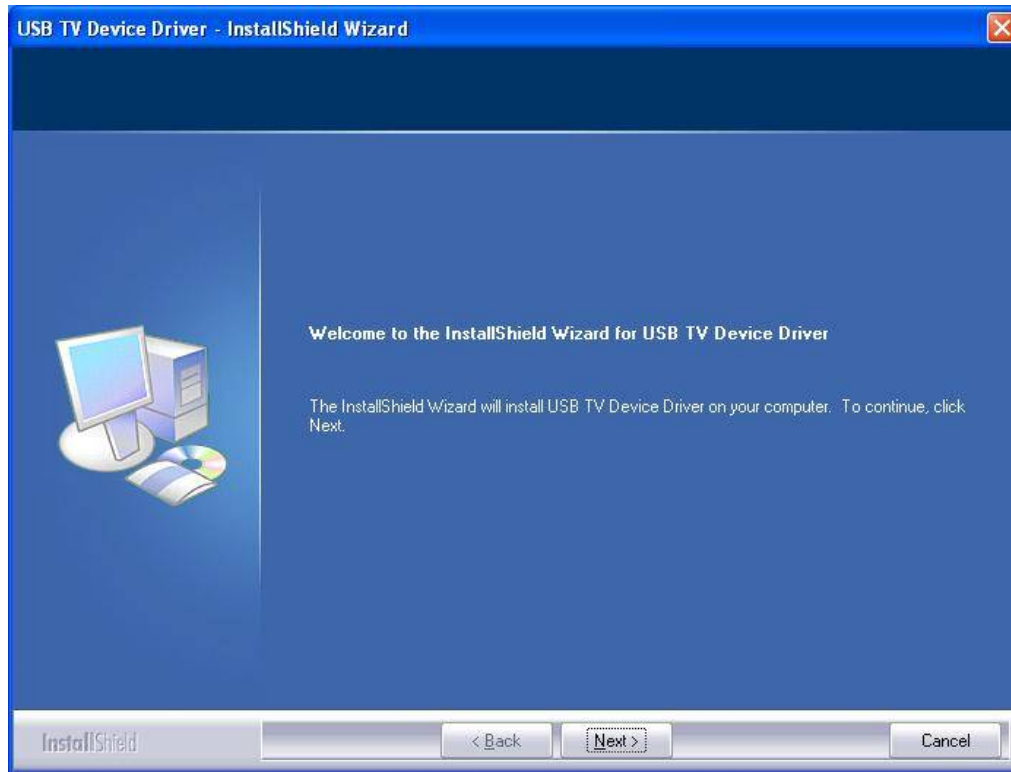

You will get another picture, please click "Finish" key.

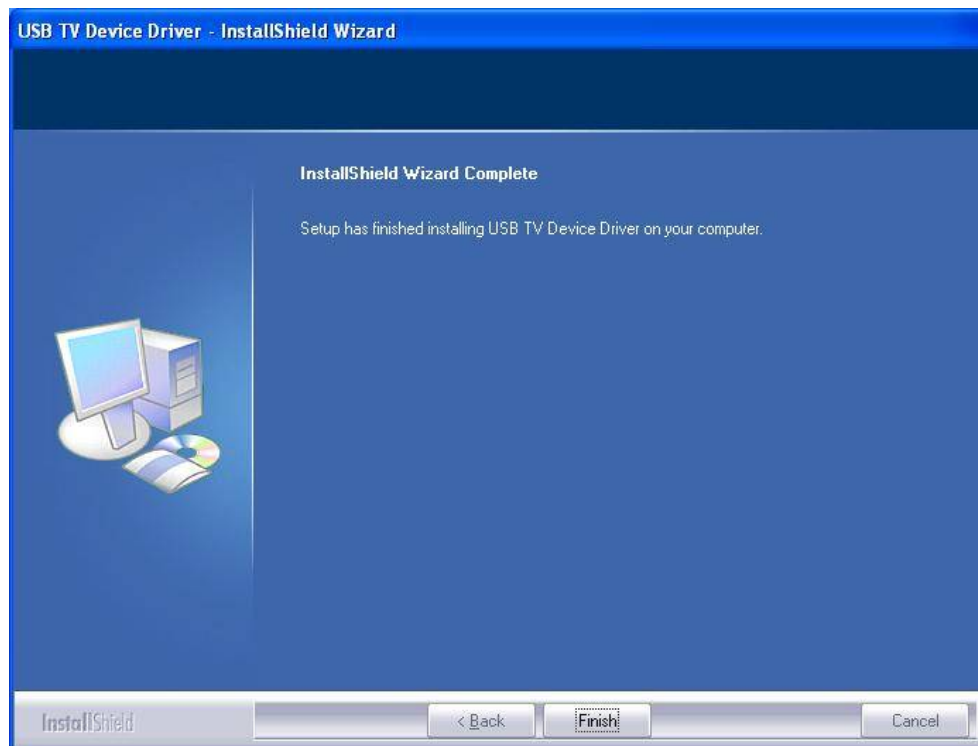

ezcap

USB 2.0 Video Capture

System will appear you to restart your computer, please select “Yes, I want to restart my computer now.” and click “Finish” key to restart your computer.

Now you need to plug the **ezcap™ USB 2.0 Video Capture** into USB 2.0 port.

If prompted select “No, not this time” and select “Next”. Select the option “Install the software automatically” and click “Next”.

A window may appear about the “USB 2861 Device” not passing the windows logo testing, select “Continue Anyway”.

When “Completing the Found New Hardware Wizard” window appears click the “Finish” button to complete the driver installation.

Note: If any further components are found please repeat the above process until you receive the message “Found new hardware: Your hardware is installed and configured use”.

You will now need to check that the drivers are installed correctly. Connect the EzCAP Video Grabber to your computer, Right Click on My Computer and Left Click on properties. Click on Hardware tab and then Device Manager. In the Device Manager click on the “Sound, video and game controllers” correctly you should see the “USB 2861 Device” and “USB EMP Audio Device”. If it has a Yellow mark next to it then this means that the driver is not installed correctly. You will need to remove the driver and disconnect the EzCAP Video Grabber from the computer and reconnect is to install the driver again.

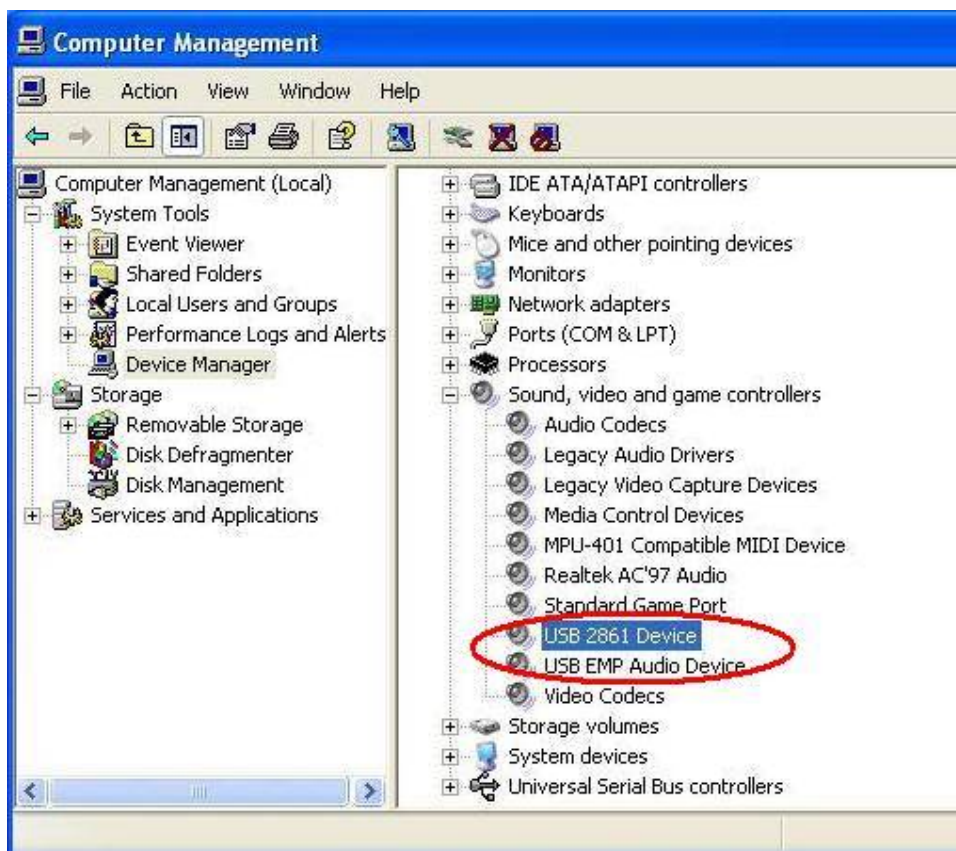

You can check the driver version for “USB 2861 Device” and “USB EMP Audio Device”.

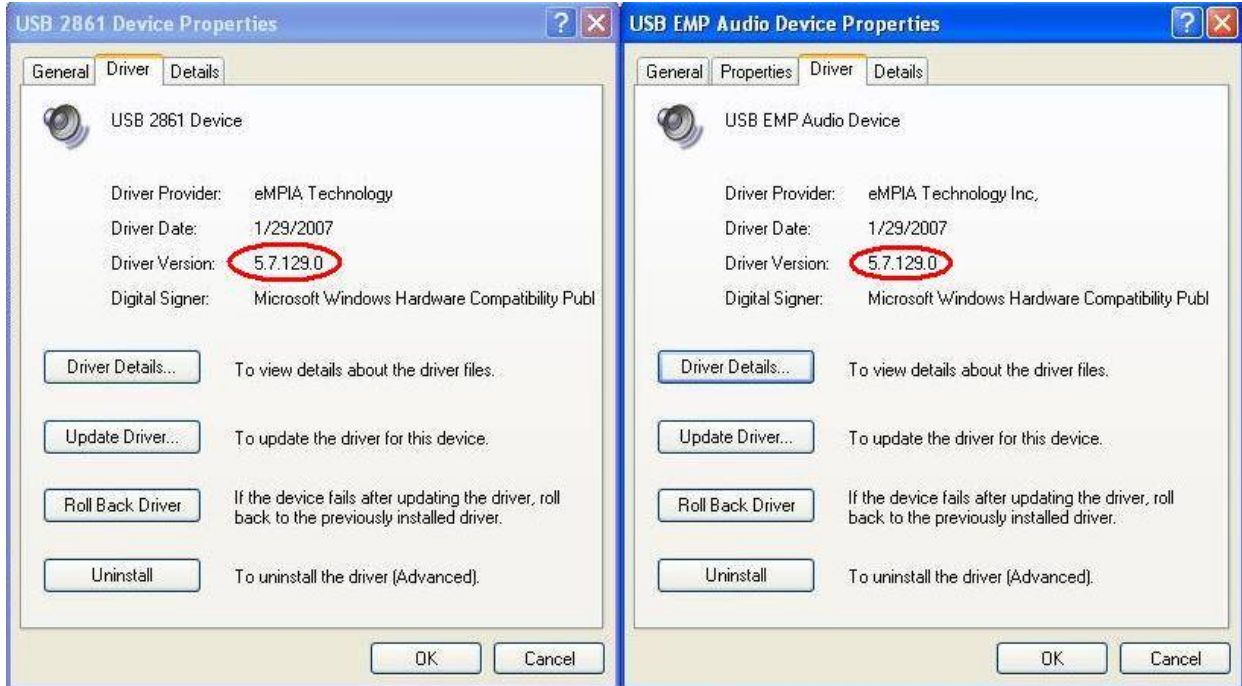

ShowBiz DVD 2 Installation & Guide

Please back to software running picture, and option "Install ShowBiz DVD 2" and select your language for the installation. And click "Next" or/and "Install".

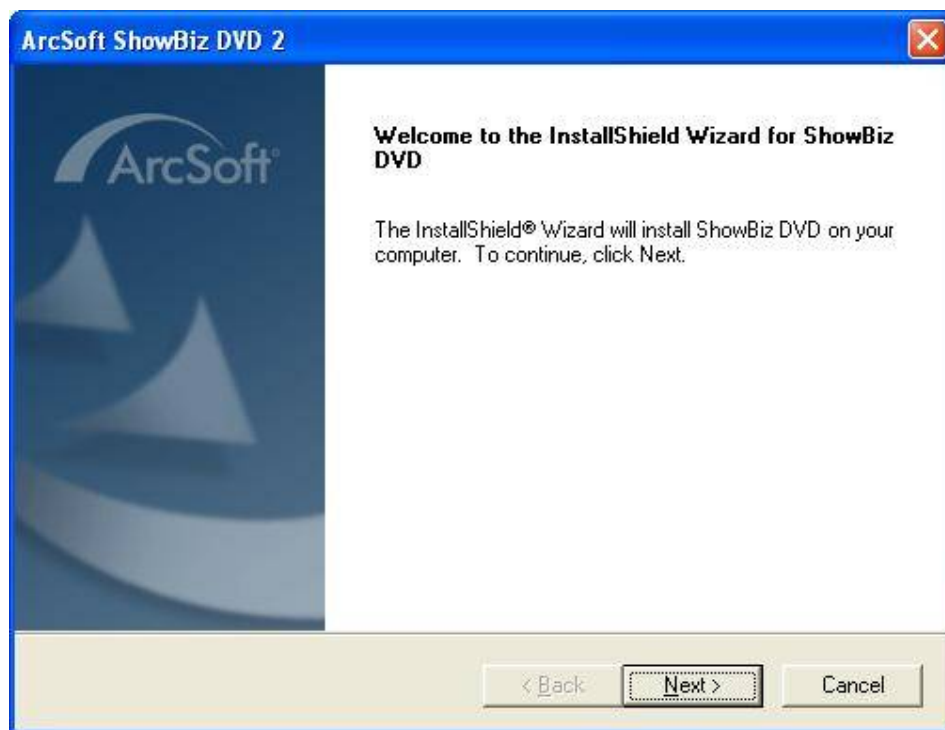

You need enter user name and serial number (you can find out the serial number on CD-ROM bag).

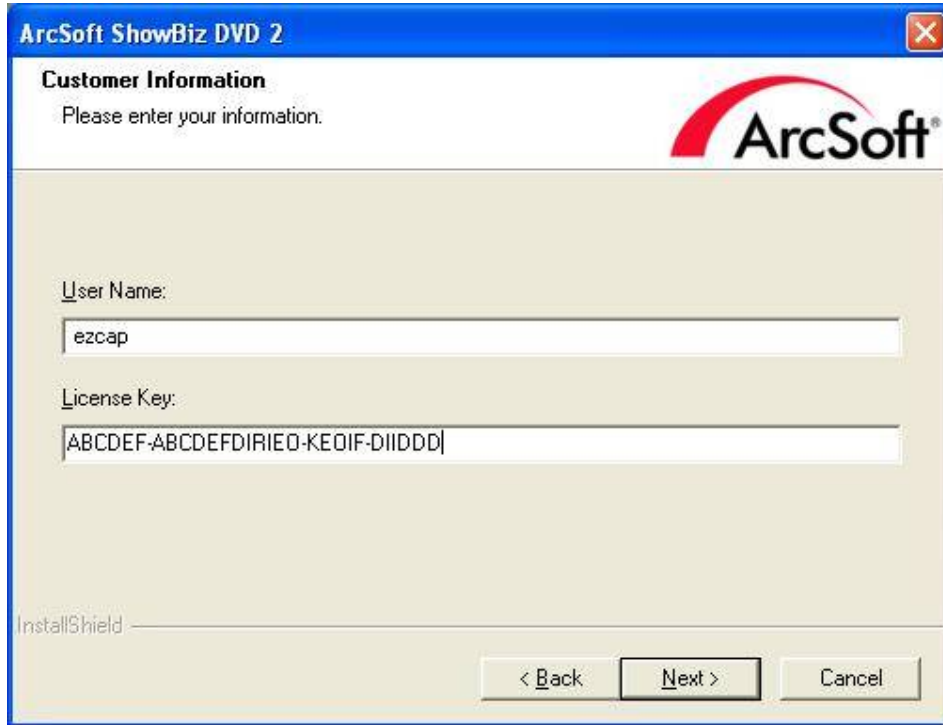

System will install the software, and you can choose destination location and folder. Then click "Next" to continue installation.

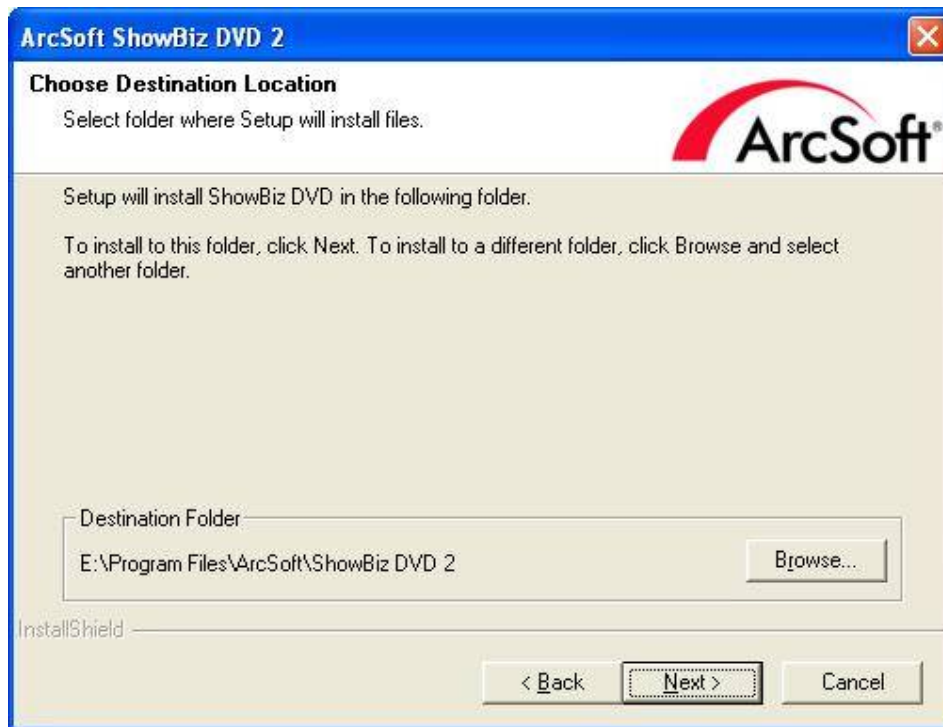

Click "finish" to complete setup, restart your computer if needed.

Now, you need to set software for capturing and editing video and audio.

Double click “ShowBiz DVD 2” icon on your desktop, select “Capture, create and edit video” and “Capture From Device”.



You can see “USB 2861 Device” is for Video Device selection.

You should click “Audio Device” and select “USB Audio Device” option.

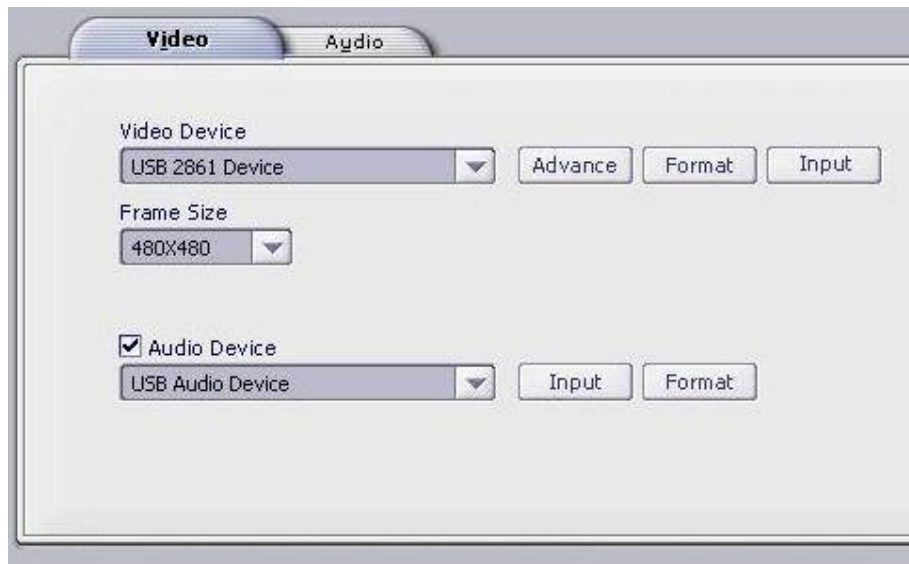

You can click “Input” of Video Device to select “Composite Video” or “S-Video” for your video source.



You can click "Advance" to choose "NTSC_M", "PAL_B" and others for your TV system.

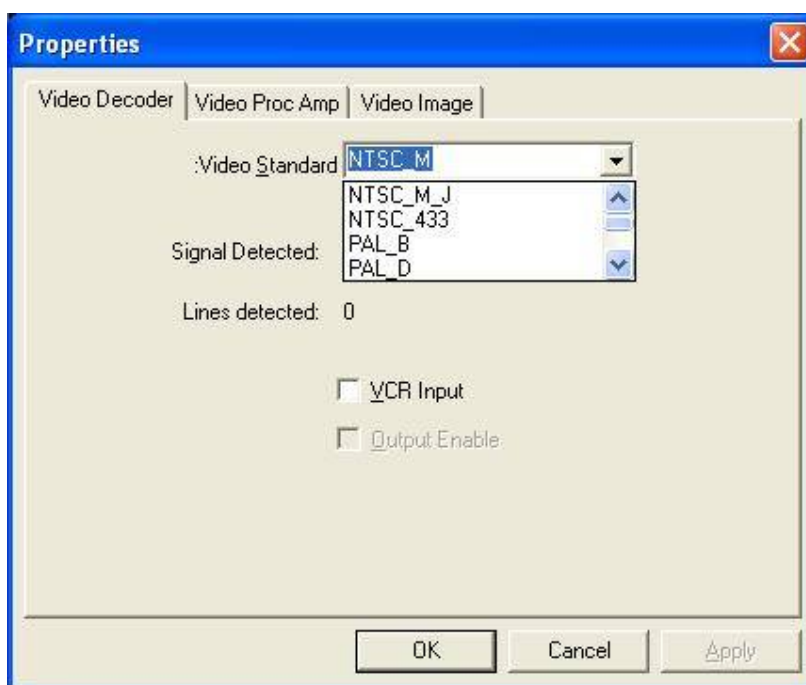

Please click "Record" key to set for recordings.
Click "Open" to change the recording files location.

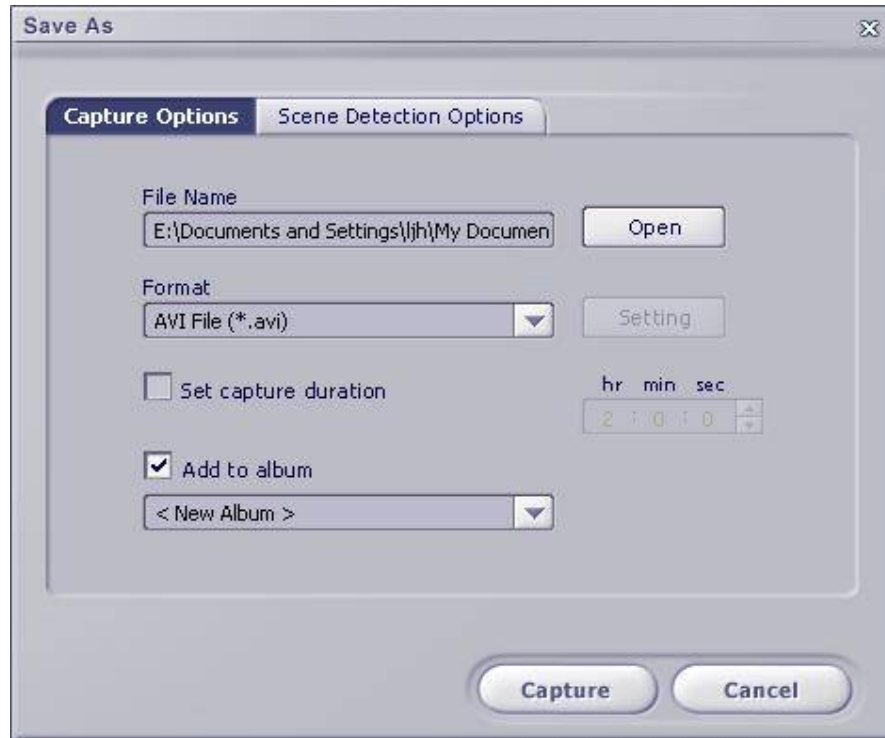

Click "AVI File" of Format to change the format of recording files.



Please click "Edit" key to edit your video files.



And you can click "Create" key to burn DVD.

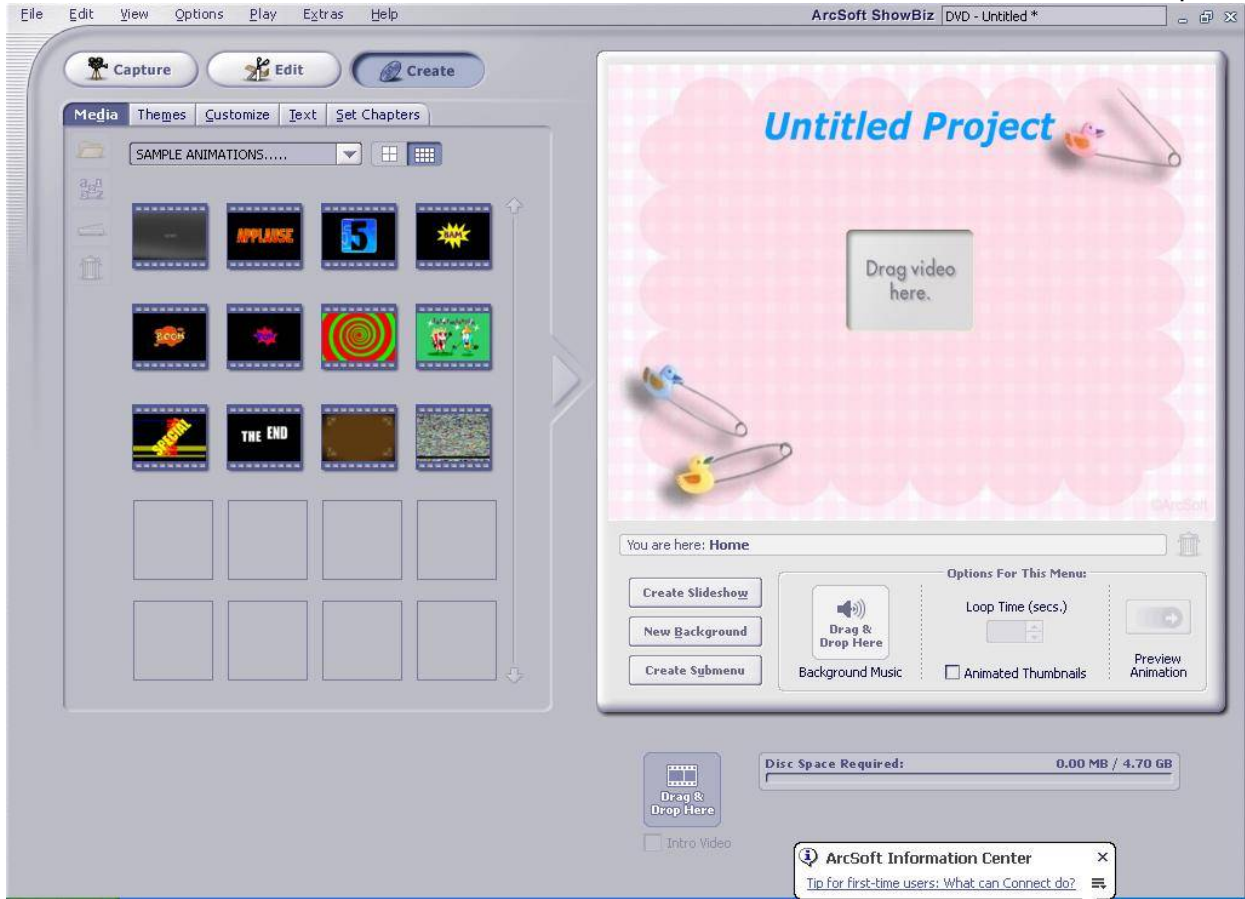

For more detailed instructions for using ShowBiz DVD 2, please click "Help" key on panel to get them.

BlazeVideo Magic 3.0 Installation & Guide

Please back to software running picture, and option "Install Magic". And select your language for the installation. And click "Next" or/and "Install".

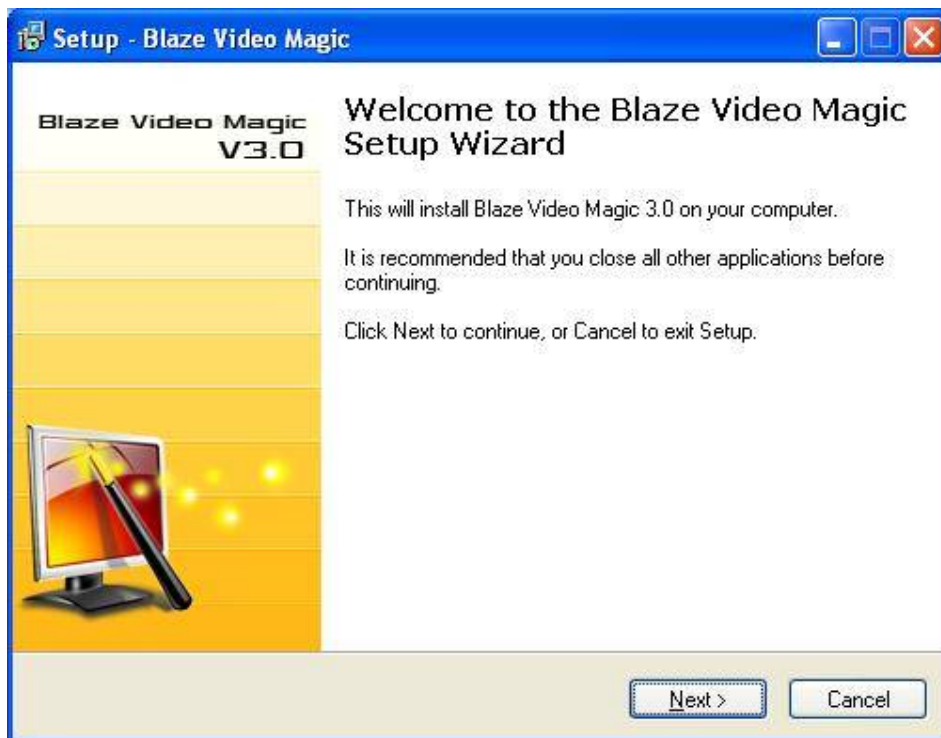

Please click "Register" key when the system appears you the picture as below.



You need enter user name and serial number (you can find out the serial number on driver CD bag).



Click "finish" to complete setup, restart your computer if needed.

Now, you need to set software for convert video and audio.

Double click "BlazeVideo Magic 3.0" icon on your desktop.



Please click "Add" key to add the video files.



Note: Please select the file that you won't convert and click "Delete" key if you won't convert some files.

Please click the gap of "Output Format", and select the video format.



You also can set the output video setting, please click “Setting” key.

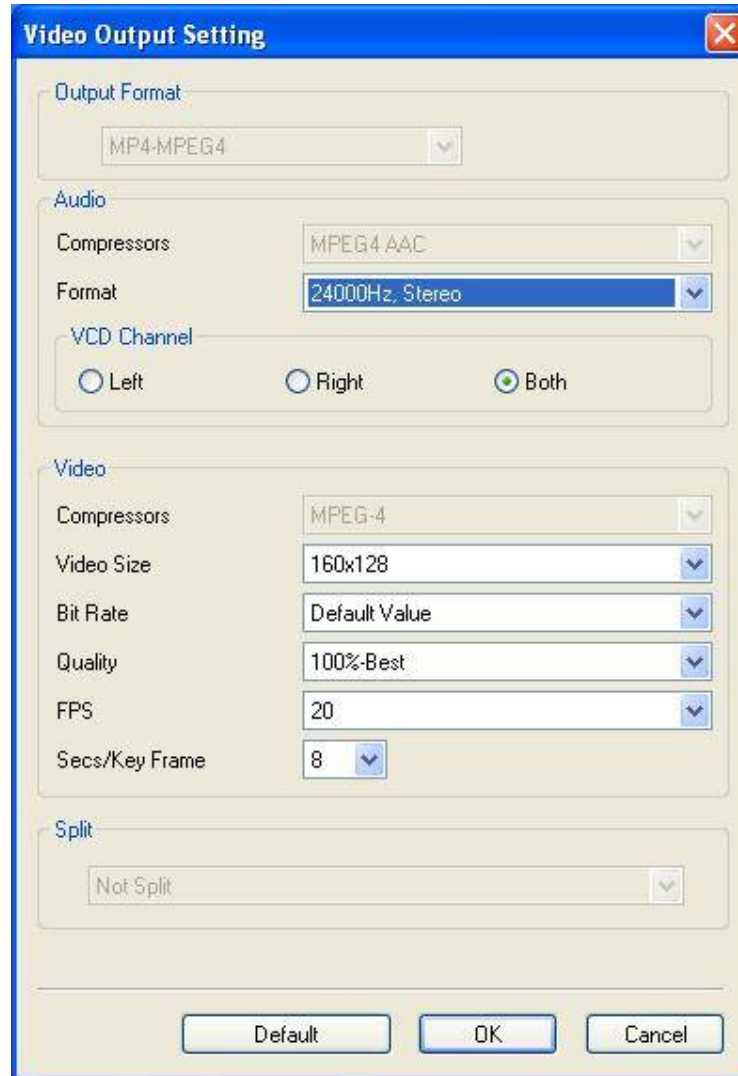

Please click “Browse” key if you want to change the converting files folder.

Now, please click “Start” key to start to convert the video files to the other digital format that you want.

Please click “?” key to get the help If you want to get the more information of BlazeVideo Magic software.

Frequently Asked Questions

Question: I am unable to connect ezcap™ USB 2.0 Video Capture to my VCR / camcorder / DVD player – what can I do?

Answer: When you buy a VCR, camcorder or DVD player you are usually supplied with an 'RGB lead'. This lead has three yellow, red and white connectors at each end, or alternatively it may have these connectors at one end and a Scart jack at the other end.

Question: Which lead do I need?

Answer: 1, If your player features a set of three red, yellow and white jacks at the back of the unit then you will need a RGB to RGB lead to connect the **ezcap™ USB 2.0 Video Capture** to your PC.

2, If your player features a Scart socket at the back of the unit then you will need a RGB to Scart lead to connect the **ezcap™ USB 2.0 Video Capture** to your PC.

Question: I have tried to install but keep getting a message saying not “compatible with Microsoft logo testing”. Will this cause problems with other software?

Answer: It will not cause problems with other software. All it means is the software hasn't been tested with Microsoft but is compatible with Windows.

Question: If you have a 'mono' camcorder, when you connect it up you may get no audio whatsoever. Must I have a stereo camcorder?

Answer: **ezcap™ USB 2.0 Video Capture** can work with a 'mono' camcorder.

Question: Can you see what you are recording?

Answer: A small window is found at the top of the screen to show what you are recording.

Question: Is the ezcap™ USB 2.0 Video Capture compatible with Mac?

Answer: Yes, but you need the **ezcap™ USB 2.0 Video Capture** Model ezcap128 hardware for Mac.

Question: If my Video is e.g. 180mins long, will it take this long to transfer via the ezcap™ USB 2.0 Video Capture?

Answer: Yes

Question: Can the ezcap™ USB 2.0 Video Capture record audio tapes onto my PC?

Answer: No, but you can buy the **ezcap™ USB 2.0 Audio Capture** Model ezcap216 or ezcap219 hardware.

Question: Can the ezcap™ USB 2.0 Video Capture be used to record videos from other devices such as a Sky box or straight from a television, or anything along those lines?

Answer: Yes it can. As long as the device you wish to record from has the relevant outputs required (Red, White and Yellow phono video lead). These must be outputs and not inputs otherwise it will not work. Please check the device's manual first to see whether your device has the outputs needed.

Question: The device I wish to record from does not have the red, white and yellow outputs can I still use the ezcap™ USB 2.0 Video Capture?

Answer: Yes you can but you will need to buy an adaptor to do so. It can be connected via a Scart output on the device you wish to record from using an adaptor which looks like a small box with red, white and yellow outputs on it. These adaptors can be bought at most electrical shops.

Question: Can I copy original movies onto my computer using the ezcap™ USB 2.0 Video Capture?

Answer: No, this is illegal. It is piracy to copy a film and then sell or lend it to another person without permission to do so.

Question: Will the videos I record onto my computer take up much space?

Answer: Yes they will. Video files are large files. You can choose the quality of the video to save space on your computer. The lower quality for the smaller file.

Question: How long will it take to record?

Answer: This is a real time capture device therefore it will take 3 hours to record a 3 hour tape.

Question: How many hours of video tape will produce 1GB of digital data.

Answer: The space depends on which format and which size you choose. For example: in AVI format there is no compression of data, and therefore it produces about 1GB for 10 minutes recording. However it only uses around 200MB if using MPEG format, and only about 30MB if using WMV format.

Question: Is the ezcap™ USB 2.0 Video Capture compatible with the old style video 8mm camcorders?

Answer: Yes it is. You will have to by a connection lead. You may require an RGB lead.